

Features

- Pairs with KOHLER Verticyl rectangular under-mount bathroom sinks.
- Pilot holes for 4" (102 mm) centerset, 8" (203 mm) widespread, or single-hole faucet installation.
- Sculpted edge.
- Coordinates with the industry-standard 60" (1524 mm) KOHLER vanities.
- Field trimmable for alcove and corner installations.
- Optional side and backsplashes available (sold separately).

Material

- Solid surface.

Installation

- Vanity top.
- Includes mounting hardware for sink.
- Accommodates single, 4" centerset, and 8" widespread faucet configurations.

Required Products/Accessories

K-2882 Undermount bathroom sink

Recommended Products/Accessories

K-23723 Faucet cleaner

Included Components

Additional Components:
Mounting Screws



Codes/Standards





None Applicable

KOHLER® One-Year Limited Warranty

See website for detailed warranty information.

Available Colors/Finishes

Color tiles intended for reference only.

Color	Code	Description
	S33	White Expressions
	S34	Almond Expressions
	S35	Biscuit Expressions
	S36	Ice Grey Expressions

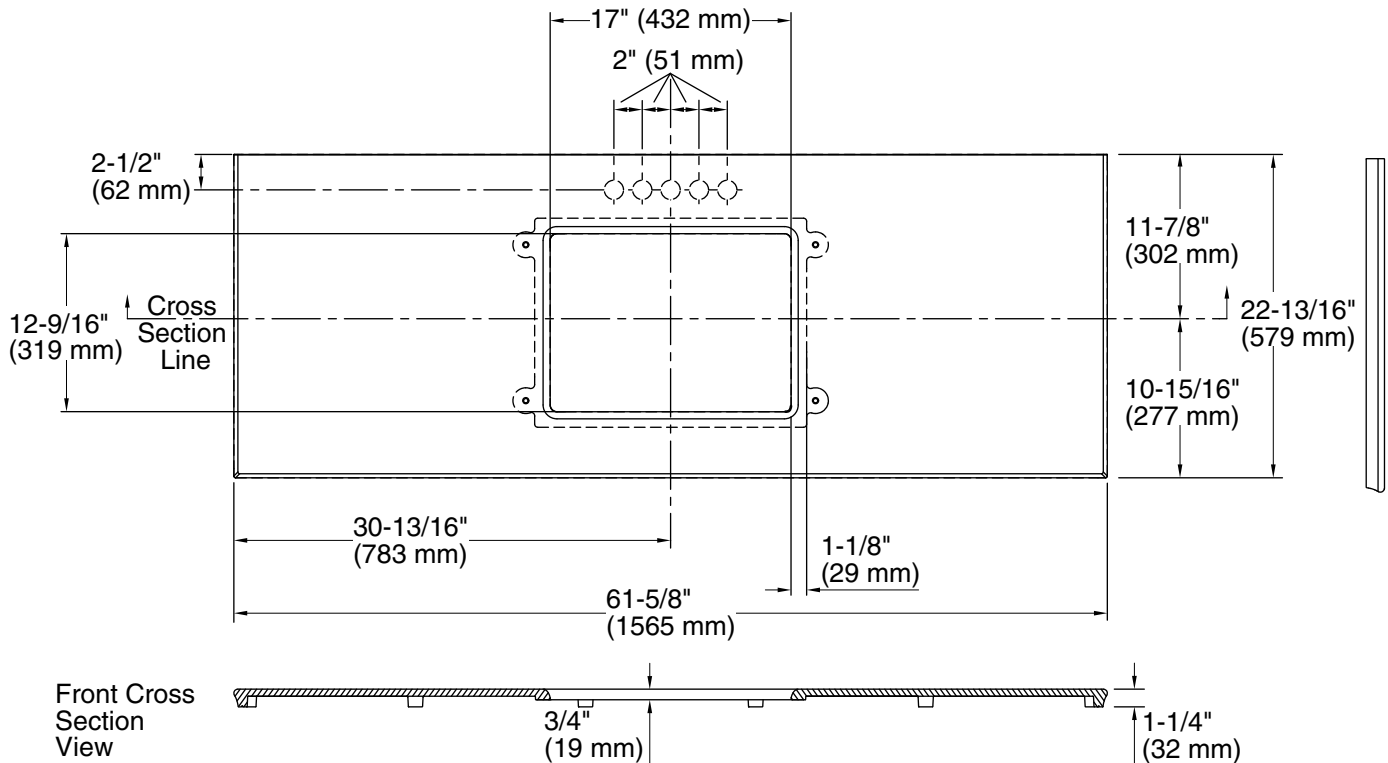

Technical Information

All product dimensions are nominal.

Bowl configuration: Single

Installation: Vanity top/ITB

Bowl area (Only): Length: 17" (432 mm)
Width: 12-9/16" (319 mm)

Notes

Install this product according to the installation instructions.

Observe all local plumbing and building codes.

This countertop is designed to be installed with a KOHLER or standard-size vanity.

Faucet hole and sink-mounting locations are marked on the underside of the countertop.